

FITTING NUMBER	
40065000	
FITTING	SIZE
ADAPTER	6"

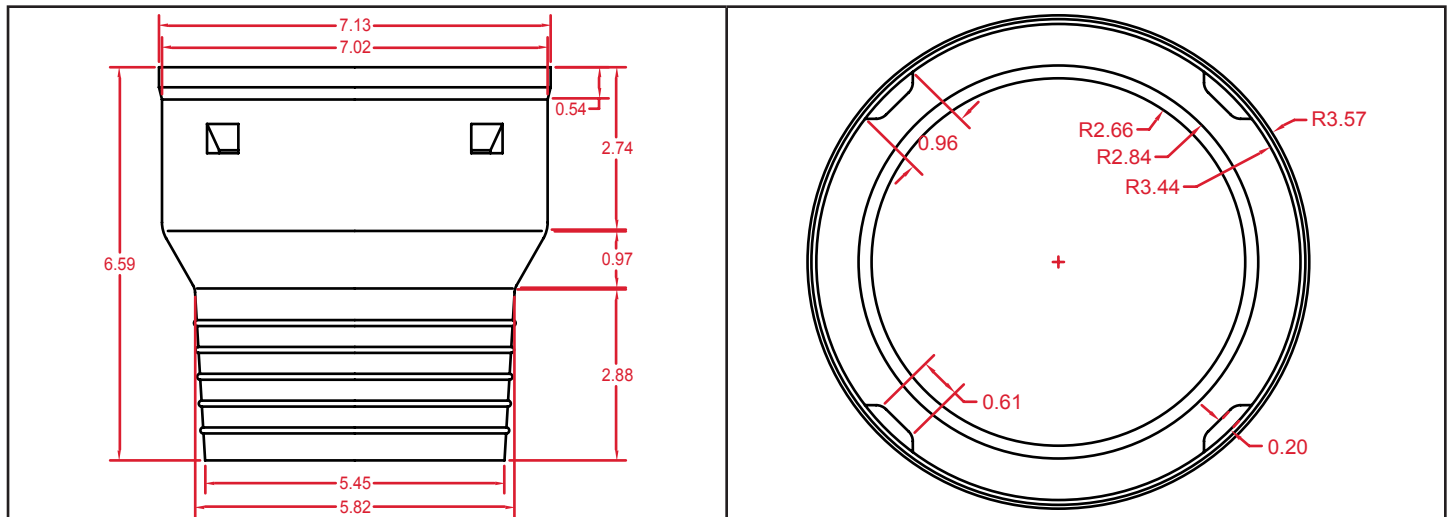

MEASUREMENTS



PART WEIGHT

110 grams (+/- 10 grams)

PART WALL DISTRIBUTION

.08"

These specifications are held in standard according to ASTM F667 - Standard Specification for Polyethylene Plastics Pipe and Fittings material.