

FITTING NUMBER	
<b>40105000</b>	
FITTING	SIZE
<b>ADAPTER</b>	<b>10"</b>

### MEASUREMENTS

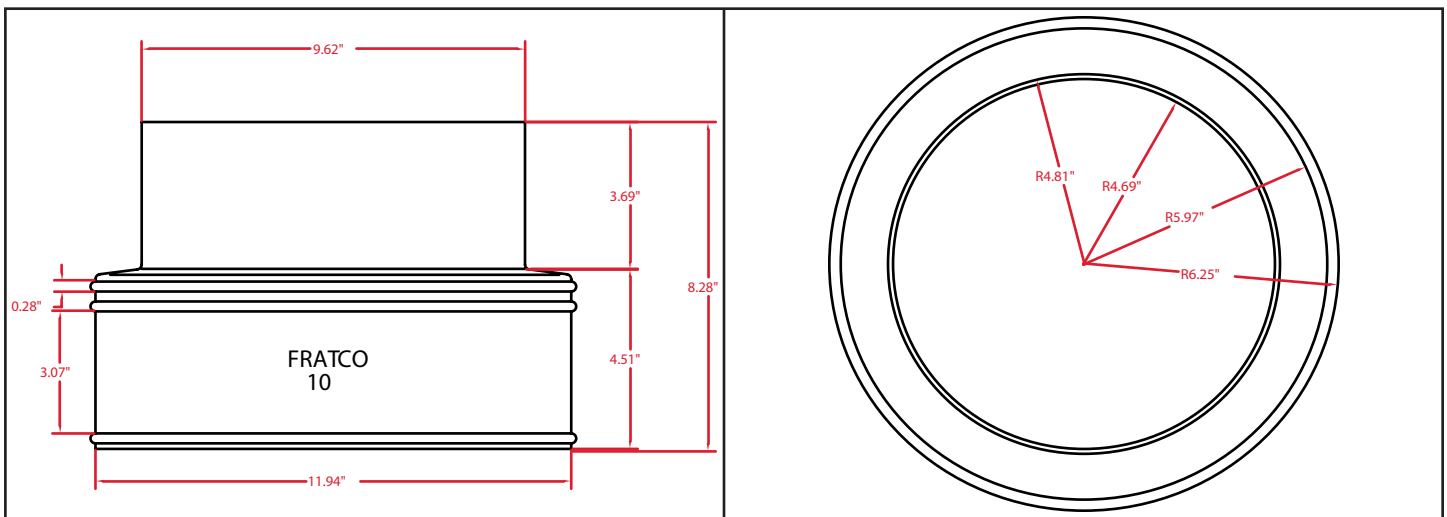

### PART WEIGHT

**460 grams** (+/- 25 grams)

### PART WALL DISTRIBUTION

**.124"**

These specifications are held in standard according to ASTM F667 - Standard Specification for Polyethylene Plastics Pipe and Fittings material.