

FITTING NUMBER

40042200

FITTING

BLIND TEE

SIZE

4"



MEASUREMENTS

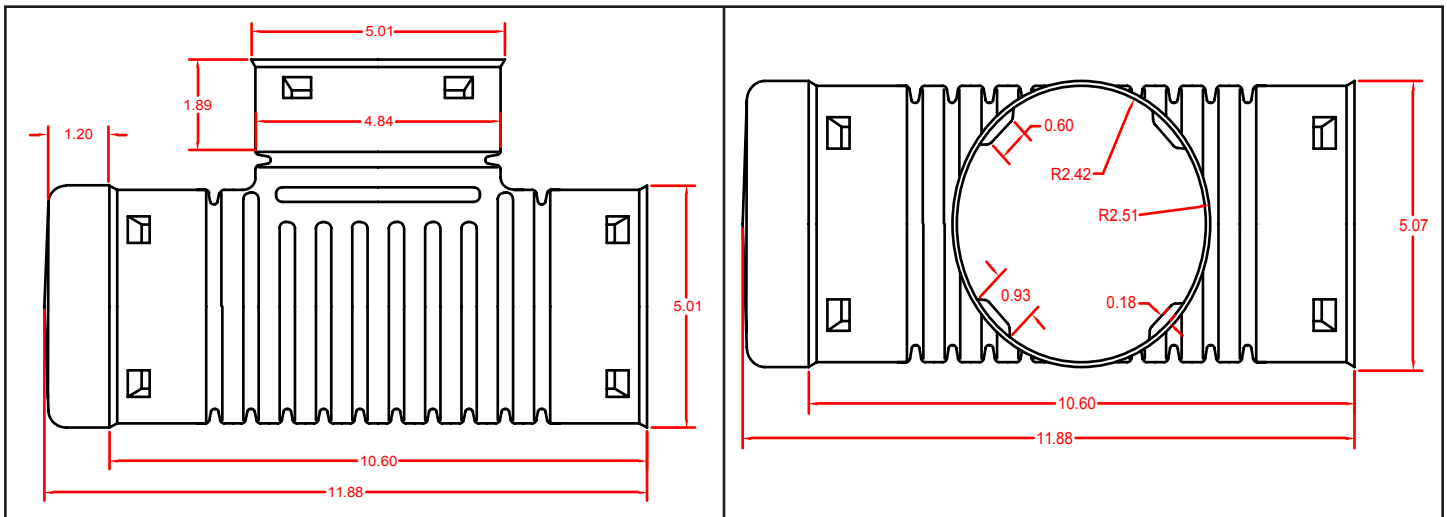

PART WEIGHT

245 grams (+/- 15 grams)

PART WALL DISTRIBUTION

.07"

These specifications are held in standard according to ASTM F667 - Standard Specification for Polyethylene Plastics Pipe and Fittings material.