

FITTING NUMBER	
40105000	
FITTING	SIZE
ADAPTER	10"

MEASUREMENTS

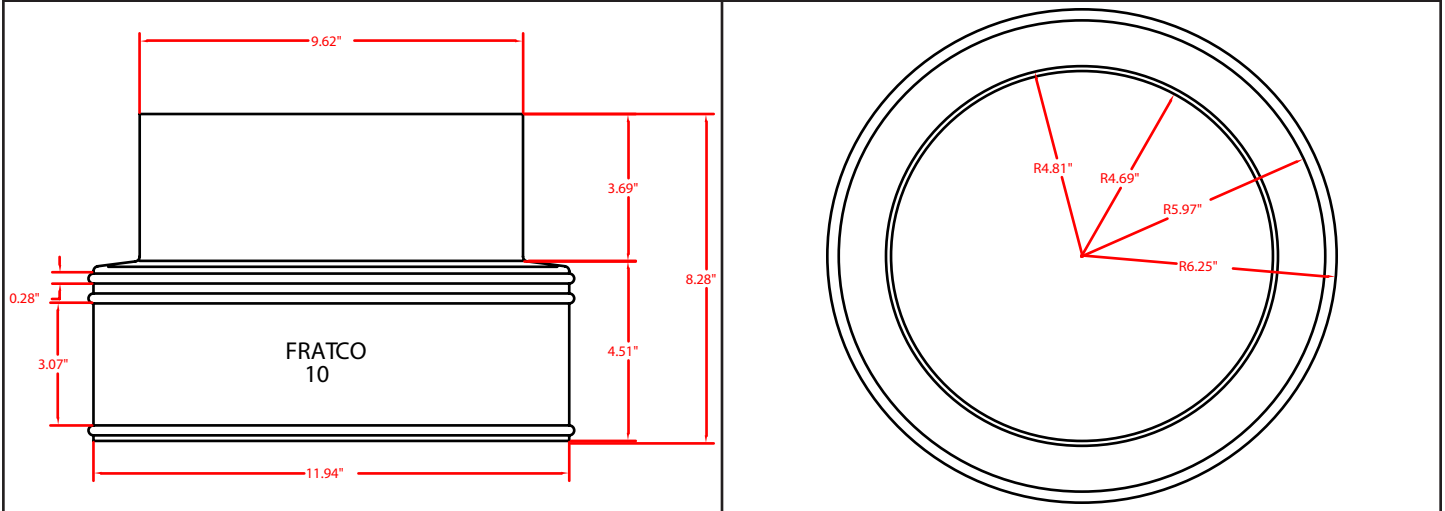

PART WEIGHT

460 grams (+/- 25 grams)

PART WALL DISTRIBUTION

.124"

These specifications are held in standard according to ASTM F667 - Standard Specification for Polyethylene Plastics Pipe and Fittings material.